





Catégorie

Category – Kategorie – Categoria – Categoría

Lisse Star
Référence

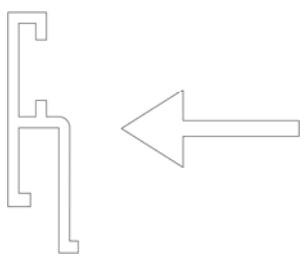
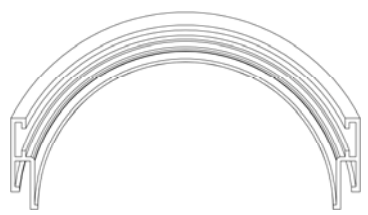
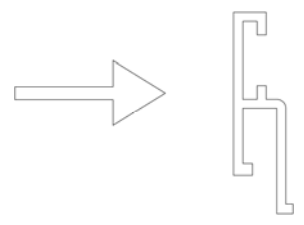
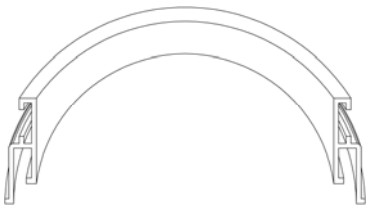
Reference – Referenz – Seferencia – Riferimento

BSC 350/01

	DENOMINATION DESCRIPTION BESCHREIBUNG DESCRIPCION DESCRIZIONE	SENS DIRECTION OF RADII RICHTUNG - SENTIDO - SENSO	SCHEMA VIEW - ZEICHNUNG - ESQUEMA SCHEMA	R MINI (mm) MINIMUM RADIUS MINIMALER RADIUS RADIO MINIMO RAGGIO MINIMO
A	Plat concave Concave vertical plane Konkav Rundung Plano concavo Piano concavo			250
B	Plat convexe Convex vertical plane Konvex Rundung Plano convexo Piano convesso			250
C	Chant concave Concave horizontal plane Konkav Rundung Canto concavo Taglio concavo			500
D	Chant convexe Convex horizontal plane Konkav Rundung Canto convexo Taglio convesso			300

N° CLIENT :

Customer – Kunde – Cliente – Cliente

COMMANDE du / /

Order of – Bestellung Datum – Pedido del – Ordine del

CINTRAGE BENDING – BIEGUNGS – CURVATURA – CALANDRATURA	A	B	C	D
QUANTITE QUANTITY – MENGE – CANTIDAD – QUANTITA				
RAYON (mm) RADIUS – RADIUS – RADIO – RAGGIO				
LONGUEUR DEVELOPPE (mm) DEVELOPPED LENGHT – ENTWICKELTE LÄNGE – DESARROLLO DE LA CURVA – LUNGHEZZA SVILUPPATA				







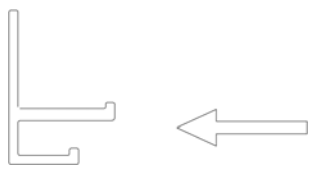

Catégorie
Lisse Star

Category – Kategorie – Categoria – Categoría

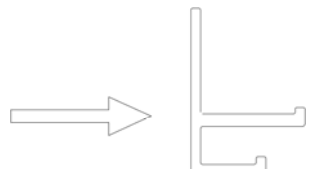
Référence
BSC 350/11

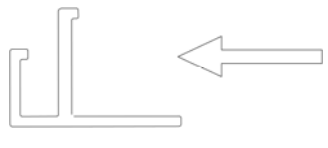
Reference – Referenz – Seferencia – Riferimento

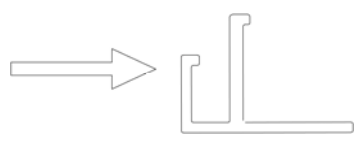

	DENOMINATION DESCRIPTION BESCHREIBUNG DESCRIPCION DESCRIZIONE	SENS DIRECTION OF RADII RICHTUNG - SENTIDO - SENSO	SCHEMA VIEW - ZEICHNUNG - ESQUEMA SCHEMA	R MINI (mm) MINIMUM RADIUS MINIMALER RADIUS RADIO MINIMO RAGGIO MINIMO
A	Plat concave Concave vertical plane Konkav Rundung Plano concavo Piano concavo			500
B	Plat convexe Convex vertical plane Konvex Rundung Plano convexo Piano convesso			600
C	Chant concave Concave horizontal plane Konkav Rundung Canto concavo Taglio concavo			300
D	Chant convexe Convex horizontal plane Konkav Rundung Canto convexo Taglio convesso			300

N° CLIENT :

Customer – Kunde – Cliente – Cliente

COMMANDE du / /

Order of – Bestellung Datum – Pedido del – Ordine del

CINTRAGE BENDING – BIEGUNGS – CURVATURA – CALANDRATURA	A	B	C	D
QUANTITE QUANTITY – MENGE – CANTIDAD – QUANTITA				
RAYON (mm) RADIUS – RADIUS – RADIO – RAGGIO				
LONGUEUR DEVELOPPE (mm) DEVELOPPED LENGHT – ENTWICKELTE LÄNGE – DESARROLLO DE LA CURVA – LUNGHEZZA SVILUPPATA				







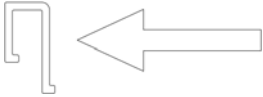

Catégorie **Lisse Star**

Category – Kategorie – Categoria – Categoria

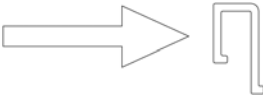
 Référence **Barridalle BDC 310/01**

Reference – Referenz – Seferencia – Riferimento







	DENOMINATION DESCRIPTION BESCHREIBUNG DESCRIPCION DESCRIZIONE	SENS DIRECTION OF RADII RICHTUNG - SENTIDO - SENSO	SCHEMA VIEW - ZEICHNUNG - ESQUEMA SCHEMA	R MINI (mm) MINIMUM RADIUS MINIMALER RADIUS RADIO MINIMO RAGGIO MINIMO
A	Plat concave Concave vertical plane Konkav Rundung Plano concavo Piano concavo			500
B	Plat convexe Convex vertical plane Konvex Rundung Plano convexo Piano convesso			450
C	Chant concave Concave horizontal plane Konkav Rundung Canto concavo Taglio concavo			200
D	Chant convexe Convex horizontal plane Konkav Rundung Canto convexo Taglio convesso			200

N° CLIENT :
 Customer – Kunde – Cliente – Cliente

COMMANDE du / /
 Order of – Bestellung Datum – Pedido del – Ordine del

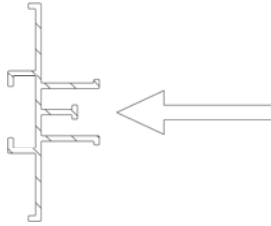
CINTRAGE BENDING – BIEGUNGS – CURVATURA – CALANDRATURA	A	B	C	D
QUANTITE QUANTITY – MENGE – CANTIDAD – QUANTITA				
RAYON (mm) RADIUS – RADIUS – RADIO – RAGGIO				
LONGUEUR DEVELOPPE (mm) DEVELOPPED LENGHT – ENTWICKELTE LÄNGE – DESARROLLO DE LA CURVA – LUNGHEZZA SVILUPPATA				

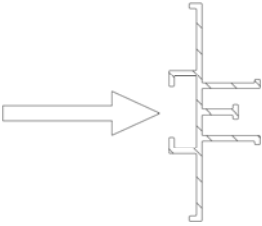
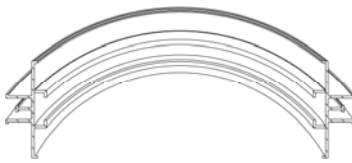

	DENOMINATION DESCRIPTION BESCHREIBUNG DESCRIPCION DESCRIZIONE	SENS DIRECTION OF RADII RICHTUNG - SENTIDO - SENSO	SCHEMA VIEW - ZEICHNUNG - ESQUEMA SCHEMA	R MINI (mm) MINIMUM RADIUS MINIMALER RADIUS RADIO MINIMO RAGGIO MINIMO
A	Plat concave Concave vertical plane Konkav Rundung Plano concavo Piano concavo			280
B	Plat convexe Convex vertical plane Konvex Rundung Plano convexo Piano convesso			230
C	Chant concave Concave horizontal plane Konkav Rundung Canto concavo Taglio concavo			Non cintrable Unbendable X

N° CLIENT :





Customer – Kunde – Cliente – Cliente

COMMANDE du / /

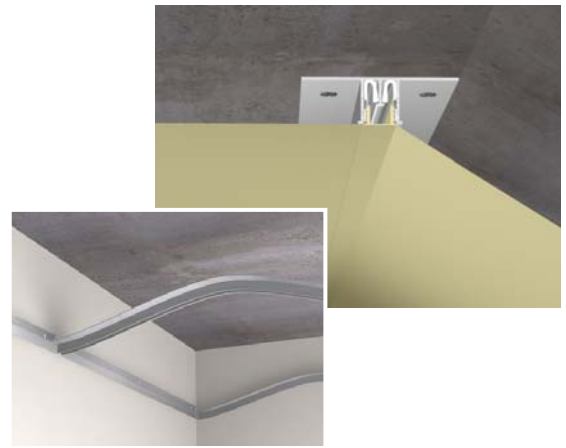
Order of – Bestellung Datum – Pedido del – Ordine del

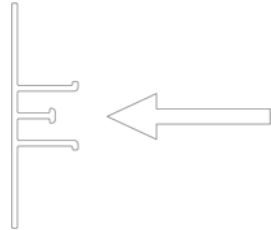
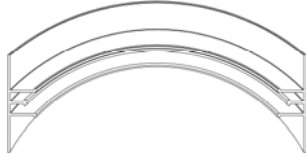
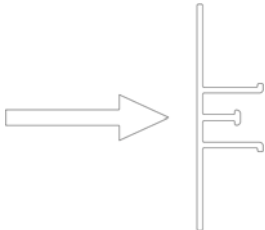
CINTRAGE BENDING – BIEGUNGS – CURVATURA – CALANDRATURA	A	B	C	D
QUANTITE QUANTITY – MENGE – CANTIDAD – QUANTITA				
RAYON (mm) RADIUS – RADIUS – RADIO – RAGGIO				
LONGUEUR DEVELOPPE (mm) DEVELOPPED LENGHT – ENTWICKELTE LÄNGE – DESARROLLO DE LA CURVA – LUNGHEZZA SVILUPPATA				



	DENOMINATION DESCRIPTION BESCHREIBUNG DESCRIPCION DESCRIZIONE	SENS DIRECTION OF RADII RICHTUNG - SENTIDO - SENSO	SCHEMA VIEW - ZEICHNUNG - ESQUEMA SCHEMA	R MINI (mm) MINIMUM RADIUS MINIMALER RADIUS RADIO MINIMO RAGGIO MINIMO
A	Plat concave Concave vertical plane Konkav Rundung Plano concavo Piano concavo			250
B	Plat convexe Convex vertical plane Konvex Rundung Plano convexo Piano convesso			250
C	Chant concave Concave horizontal plane Konkav Rundung Canto concavo Taglio concavo			Non cintrable Unbendable X

N° CLIENT :







Customer – Kunde – Cliente – Cliente

COMMANDE du / /

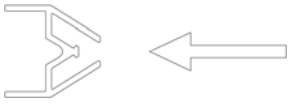
Order of – Bestellung Datum – Pedido del – Ordine del

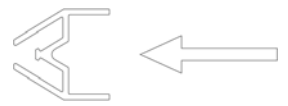
CINTRAGE BENDING – BIEGUNGS – CURVATURA – CALANDRATURA	A	B	C	D
QUANTITE QUANTITY – MENGE – CANTIDAD – QUANTITA				
RAYON (mm) RADIUS – RADIUS – RADIO – RAGGIO				
LONGUEUR DEVELOPPE (mm) DEVELOPPED LENGHT – ENTWICKELTE LÄNGE – DESARROLLO DE LA CURVA – LUNGHEZZA SVILUPPATA				

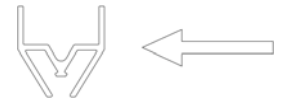

	DENOMINATION DESCRIPTION BESCHREIBUNG DESCRIPCION DESCRIZIONE	SENS DIRECTION OF RADII RICHTUNG - SENTIDO - SENSO	SCHEMA VIEW - ZEICHNUNG - ESQUEMA SCHEMA	R MINI (mm) MINIMUM RADIUS MINIMALER RADIUS RADIO MINIMO RAGGIO MINIMO
A	Plat concave Concave vertical plane Konkav Rundung Plano concavo Piano concavo			200
B	Plat convexe Convex vertical plane Konvex Rundung Plano convexo Piano convesso			250
C	Chant concave Concave horizontal plane Konkav Rundung Canto concavo Taglio concavo			Non cintrable Unbendable X

N° CLIENT :





Customer – Kunde – Cliente – Cliente

COMMANDE du / /

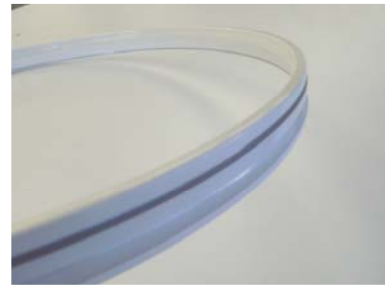
Order of – Bestellung Datum – Pedido del – Ordine del

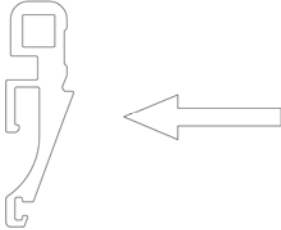
CINTRAGE BENDING – BIEGUNGS – CURVATURA – CALANDRATURA	A	B	C	D
QUANTITE QUANTITY – MENGE – CANTIDAD – QUANTITA				
RAYON (mm) RADIUS – RADIUS – RADIO – RAGGIO				
LONGUEUR DEVELOPPE (mm) DEVELOPPED LENGHT – ENTWICKELTE LÄNGE – DESARROLLO DE LA CURVA – LUNGHEZZA SVILUPPATA				

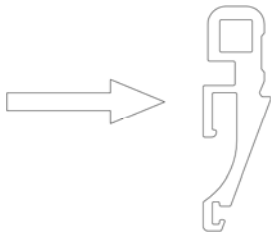
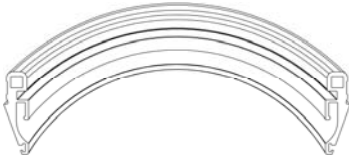

RÉFÉRENCES REFERENCE REFERENZ SEFERENCIA RIFERIMENTO	DENOMINATION DESCRIPTION BESCHREIBUNG DESCRIPCION DESCRIZIONE	SENS DIRECTION OF RADII RICHTUNG - SENTIDO - SENSO	SCHEMA VIEW - ZEICHNUNG - ESQUEMA SCHEMA	R MINI (mm) MINIMUM RADIUS MINIMALER RADIUS RADIO MINIMO RAGGIO MINIMO
BSC 355/05A	Plat concave Concave vertical plane Konkav Rundung Plano concavo Piano concavo			300
BSC 355/05B	Plat convexe Convex vertical plane Konvex Rundung Plano convexo Piano convesso			200
BSC 355/05C	Chant concave Concave horizontal plane Konkav Rundung Canto concavo Taglio concavo			Non cintrable Unbendable X

N° CLIENT :

Customer – Kunde – Cliente – Cliente

COMMANDE du / /

Order of – Bestellung Datum – Pedido del – Ordine del

CINTRAGE BENDING – BIEGUNGS – CURVATURA – CALANDRATURA	A	B	C	D
QUANTITE QUANTITY – MENGE – CANTIDAD – QUANTITA				
RAYON (mm) RADIUS – RADIUS – RADIO – RAGGIO				
LONGUEUR DEVELOPPE (mm) DEVELOPPED LENGHT – ENTWICKELTE LÄNGE – DESARROLLO DE LA CURVA – LUNGHEZZA SVILUPPATA				

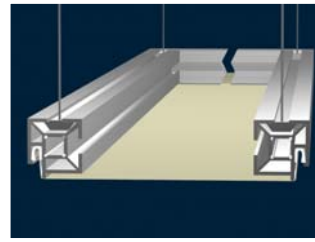



	DENOMINATION DESCRIPTION BESCHREIBUNG DESCRIPCION DESCRIZIONE	SENS DIRECTION OF RADII RICHTUNG - SENTIDO - SENSO		SCHEMA VIEW - ZEICHNUNG - ESQUEMA SCHEMA	R MINI (mm) MINIMUM RADIUS MINIMALER RADIUS RADIO MINIMO RAGGIO MINIMO
A	Plat concave Concave vertical plane Konkav Rundung Plano concavo Piano concavo				400
B	Plat convexe Convex vertical plane Konvex Rundung Plano convexo Piano convesso				300
C	Chant concave Concave horizontal plane Konkav Rundung Canto concavo Taglio concavo				400
D	Chant convexe Convex horizontal plane Konkav Rundung Canto convexo Taglio convesso				450

N° CLIENT :
Customer – Kunde – Cliente – Cliente

COMMANDE du / /
Order of – Bestellung Datum – Pedido del – Ordine del

CINTRAGE BENDING – BIEGUNGS – CURVATURA – CALANDRATURA	A	B	C	D
QUANTITE QUANTITY – MENGE – CANTIDAD – QUANTITA				
RAYON (mm) RADIUS – RADIUS – RADIO – RAGGIO				
LONGUEUR DEVELOPPE (mm) DEVELOPPED LENGHT – ENTWICKELTE LÄNGE – DESARROLLO DE LA CURVA – LUNGHEZZA SVILUPPATA				

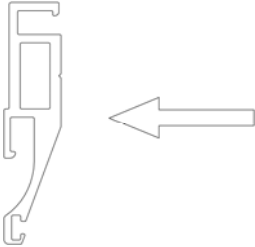

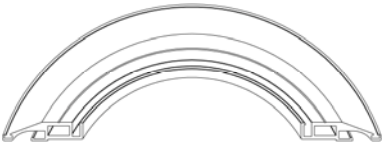
	DENOMINATION DESCRIPTION BESCHREIBUNG DESCRIPCION DESCRIZIONE	SENS DIRECTION OF RADII RICHTUNG - SENTIDO - SENSO	SCHEMA VIEW - ZEICHNUNG - ESQUEMA SCHEMA	R MINI (mm) MINIMUM RADIUS MINIMALER RADIUS RADIO MINIMO RAGGIO MINIMO
A	BSC 355/08 A Plat concave Concave vertical plane Konkav Rundung Plano concavo Piano concavo			400
B	Plat convexe Convex vertical plane Konvex Rundung Plano convexo Piano convesso	X	X	Non cintrable Unbendable X
C	Chant concave Concave horizontal plane Konkav Rundung Canto concavo Taglio concavo			Non cintrable Unbendable X

N° CLIENT :

Customer – Kunde – Cliente – Cliente

COMMANDE du / /

Order of – Bestellung Datum – Pedido del – Ordine del

CINTRAGE BENDING – BIEGUNGS – CURVATURA – CALANDRATURA	A	B	C	D
QUANTITE QUANTITY – MENGE – CANTIDAD – QUANTITA				
RAYON (mm) RADIUS – RADIUS – RADIO – RAGGIO				
LONGUEUR DEVELOPPE (mm) DEVELOPPED LENGHT – ENTWICKELTE LÄNGE – DESARROLLO DE LA CURVA – LUNGHEZZA SVILUPPATA				





Catégorie **Lisse Star**

Category – Kategorie – Categoria – Categoria

 Référence **BSC 355/10**

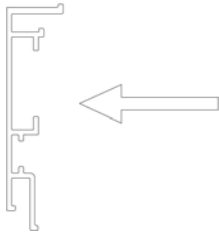
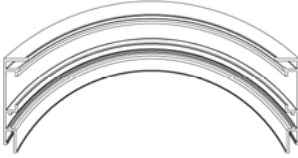
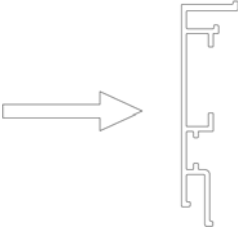
Reference – Referenz – Seferencia – Riferimento



	DENOMINATION DESCRIPTION BESCHREIBUNG DESCRIPCION DESCRIZIONE	SENS DIRECTION OF RADII RICHTUNG - SENTIDO - SENSO	SCHEMA VIEW - ZEICHNUNG - ESQUEMA SCHEMA	R MINI (mm) MINIMUM RADIUS MINIMALER RADIUS RADIO MINIMO RAGGIO MINIMO
A	Plat concave Concave vertical plane Konkav Rundung Plano concavo Piano concavo			300
B	Plat convexe Convex vertical plane Konvex Rundung Plano convexo Piano convesso			250
C	Chant concave Concave horizontal plane Konkav Rundung Canto concavo Taglio concavo			Non cintrable Unbendable X
D	Chant convexe Convex horizontal plane Konkav Rundung Canto convexo Taglio convesso			Non cintrable Unbendable X

 N° CLIENT :
Customer – Kunde – Cliente – Cliente

 COMMANDE du / /
Order of – Bestellung Datum – Pedido del – Ordine del

CINTRAGE BENDING – BIEGUNGS – CURVATURA – CALANDRATURA	A	B	C	D
QUANTITE QUANTITY – MENGE – CANTIDAD – QUANTITA				
RAYON (mm) RADIUS – RADIUS – RADIO – RAGGIO				
LONGUEUR DEVELOPPE (mm) DEVELOPPED LENGHT – ENTWICKELTE LÄNGE – DESARROLLO DE LA CURVA – LUNGHEZZA SVILUPPATA				







	DENOMINATION DESCRIPTION BESCHREIBUNG DESCRIPCION DESCRIZIONE	SENS DIRECTION OF RADII RICHTUNG - SENTIDO - SENSO	SCHEMA VIEW - ZEICHNUNG - ESQUEMA SCHEMA	R MINI (mm) MINIMUM RADIUS MINIMALER RADIUS RADIO MINIMO RAGGIO MINIMO
A	Plat concave Concave vertical plane Konkav Rundung Plano concavo Piano concavo			Entaillé 300 Sablé 500
B	Plat convexe Convex vertical plane Konvex Rundung Plano convexo Piano convesso			Entaillé 300
C	Chant concave Concave horizontal plane Konkav Rundung Canto concavo Taglio concavo			Non cintrable Unbendable X
D	Chant convexe Convex horizontal plane Konkav Rundung Canto convexo Taglio convesso			Non cintrable Unbendable X

N° CLIENT :
Customer – Kunde – Cliente – Cliente

COMMANDE du / /
Order of – Bestellung Datum – Pedido del – Ordine del

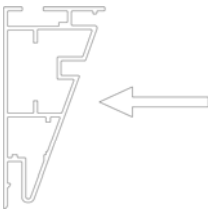
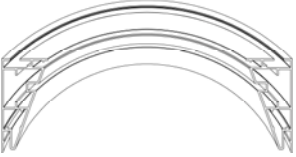
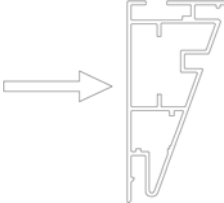
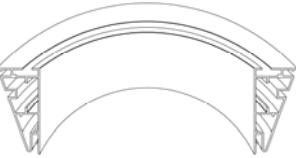
CINTRAGE BENDING – BIEGUNGS – CURVATURA – CALANDRATURA	A	B	C	D
QUANTITE QUANTITY – MENGE – CANTIDAD – QUANTITA				
RAYON (mm) RADIUS – RADIUS – RADIO – RAGGIO				
LONGUEUR DEVELOPPE (mm) DEVELOPPED LENGHT – ENTWICKELTE LÄNGE – DESARROLLO DE LA CURVA – LUNGHEZZA SVILUPPATA				



	DENOMINATION DESCRIPTION BESCHREIBUNG DESCRIPCION DESCRIZIONE	SENS DIRECTION OF RADII RICHTUNG - SENTIDO - SENSO		SCHEMA VIEW - ZEICHNUNG - ESQUEMA SCHEMA	R MINI (mm) MINIMUM RADIUS MINIMALER RADIUS RADIO MINIMO RAGGIO MINIMO
A	Plat concave Concave vertical plane Konkav Rundung Plano concavo Piano concavo			5 000 non entaillé Entaillé 300	
B	Plat convexe Convex vertical plane Konvex Rundung Plano convexo Piano convesso			5 000 non entaillé Entaillé 300	
C	Chant concave Concave horizontal plane Konkav Rundung Canto concavo Taglio concavo			Non cintrable Unbendable X	
D	Chant convexe Convex horizontal plane Konkav Rundung Canto convexo Taglio convesso			Non cintrable Unbendable X	

N° CLIENT :
Customer – Kunde – Cliente – Cliente

COMMANDE du / /
Order of – Bestellung Datum – Pedido del – Ordine del

CINTRAGE BENDING – BIEGUNGS – CURVATURA – CALANDRATURA	A	B	C	D
QUANTITE QUANTITY – MENGE – CANTIDAD – QUANTITA				
RAYON (mm) RADIUS – RADIUS – RADIO – RAGGIO				
LONGUEUR DEVELOPPE (mm) DEVELOPPED LENGHT – ENTWICKELTE LÄNGE – DESARROLLO DE LA CURVA – LUNGHEZZA SVILUPPATA				

Catégorie **Cadre modulaire**

Category – Kategorie – Categoria – Categoría

 Référence **BSC 355/25**

Reference – Referenz – Seferencia – Riferimento

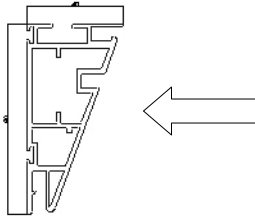
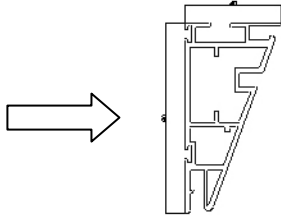

	DENOMINATION DESCRIPTION BESCHREIBUNG DESCRIPCION DESCRIZIONE	SENS DIRECTION OF RADII RICHTUNG - SENTIDO - SENSO	SCHEMA VIEW - ZEICHNUNG - ESQUEMA SCHEMA	R MINI (mm) MINIMUM RADIUS MINIMALER RADIUS RADIO MINIMO RAGGIO MINIMO
A	Plat concave Concave vertical plane Konkav Rundung Plano concavo Piano concavo			5 000 non entaillé Entaillé 300
B	Plat convexe Convex vertical plane Konvex Rundung Plano convexo Piano convesso			5 000 non entaillé Entaillé 300

N° CLIENT :

Customer – Kunde – Cliente – Cliente

COMMANDE du / /

Order of – Bestellung Datum – Pedido del – Ordine del

CINTRAGE BENDING – BIEGUNGS – CURVATURA – CALANDRATURA	A	B	C	D
QUANTITE QUANTITY – MENGE – CANTIDAD – QUANTITA				
RAYON (mm) RADIUS – RADIUS – RADIO – RAGGIO				
LONGUEUR DEVELOPPE (mm) DEVELOPPED LENGHT – ENTWICKELTE LÄNGE – DESARROLLO DE LA CURVA – LUNGHEZZA SVILUPPATA				



Catégorie **Cadre modulaire**

Category – Kategorie – Categoria – Categoria

 Référence **BSC 355/163**

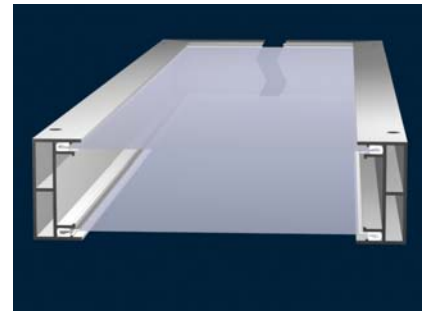
Reference – Referenz – Seferencia – Riferimento

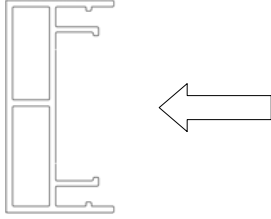

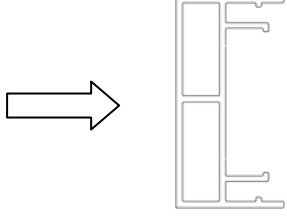
	DENOMINATION DESCRIPTION BESCHREIBUNG DESCRIPCION DESCRIZIONE	SENS DIRECTION OF RADIUS RICHTUNG - SENTIDO - SENSO	SCHEMA VIEW - ZEICHNUNG - ESQUEMA SCHEMA	R MINI (mm) MINIMUM RADIUS MINIMALER RADIUS RADIO MINIMO RAGGIO MINIMO
A	Plat concave Concave vertical plane Konkav Rundung Plano concavo Piano concavo			500
B	Plat convexe Convex vertical plane Konvex Rundung Plano convexo Piano convesso			300

N° CLIENT :

Customer – Kunde – Cliente – Cliente

COMMANDE du / /

Order of – Bestellung Datum – Pedido del – Ordine del

CINTRAGE BENDING – BIEGUNGS – CURVATURA – CALANDRATURA	A	B	C	D
QUANTITE QUANTITY – MENGE – CANTIDAD – QUANTITA				
RAYON (mm) RADIUS – RADIUS – RADIO – RAGGIO				
LONGUEUR DEVELOPPE (mm) DEVELOPPED LENGHT – ENTWICKELTE LÄNGE – DESARROLLO DE LA CURVA – LUNGHEZZA SVILUPPATA				

Catégorie **Lisse cintrée**

Category – Kategorie – Categoria – Categoria

 Référence **BSC 355/35**

Reference – Referenz – Seferencia – Riferimento

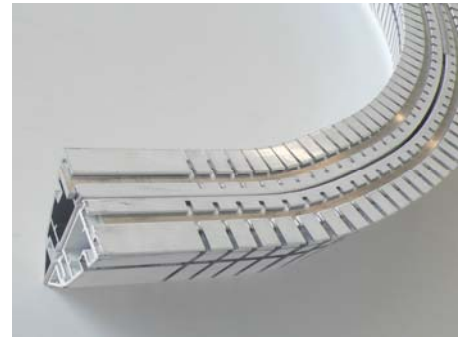

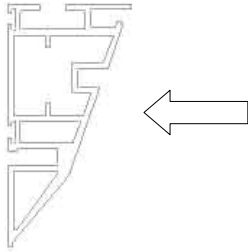
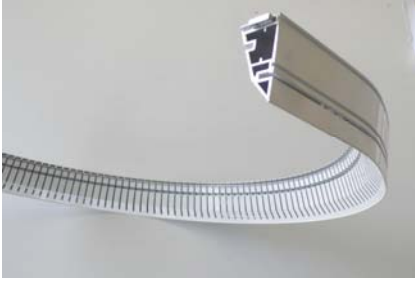
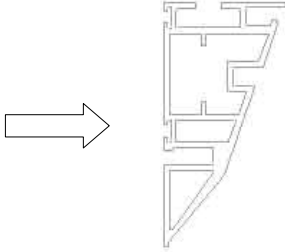
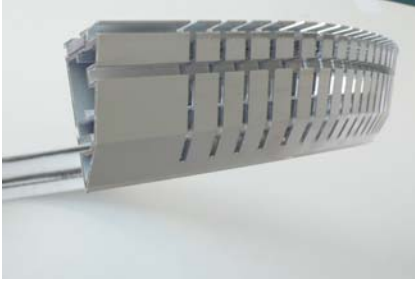
	DENOMINATION DESCRIPTION BESCHREIBUNG DESCRIPCION DESCRIZIONE	SENS DIRECTION OF RADII RICHTUNG - SENTIDO - SENSO	SCHEMA VIEW - ZEICHNUNG - ESQUEMA SCHEMA	R MINI (mm) MINIMUM RADIUS MINIMALER RADIUS RADIO MINIMO RAGGIO MINIMO
A	Plat concave Concave vertical plane Konkav Rundung Plano concavo Piano concavo			5 000 non entaillé Entaillé 300
B	Plat convexe Convex vertical plane Konvex Rundung Plano convexo Piano convesso			5 000 non entaillé Entaillé 300
C	Chant concave Concave horizontal plane Konkav Rundung Canto concavo Taglio concavo			Non cintrable Unbendable X
D	Chant convexe Convex horizontal plane Konkav Rundung Canto convexo Taglio convesso			Non cintrable Unbendable X

 N° CLIENT :
Customer – Kunde – Cliente – Cliente

 COMMANDE du / /
Order of – Bestellung Datum – Pedido del – Ordine del

CINTRAGE BENDING – BIEGUNGS – CURVATURA – CALANDRATURA	A	B	C	D
QUANTITE QUANTITY – MENGE – CANTIDAD – QUANTITA				
RAYON (mm) RADIUS – RADIUS – RADIO – RAGGIO				
LONGUEUR DEVELOPPE (mm) DEVELOPPED LENGHT – ENTWICKELTE LÄNGE – DESARROLLO DE LA CURVA – LUNGHEZZA SVILUPPATA				